

## Application

The Baufix 100 is an underfloor sump, which provides good storage capacity. Without a great deal of construction work, it disposes of effluent from laundries, storage or cellar areas below the local backup level. The application as collecting tank for sewage is not permitted.

The pressure resistant plastic tank is placed without form-work into the concrete base and forms a collecting tank for underfloor pipework. Installation in areas subject to ground water is not permitted, because the connection PE to concrete is not tight against pressing water.

The pump that has to be installed can be selected according to the amount of waste water: the U 3 KS NIRO as a dewatering station for single family property, the U 6 KS NIRO for branched piping and large volumes of waste water, pumps from the US series for a block of houses or the US 73 Ex and US 103 Ex for hazardous areas. For the disposal of condensate from condensing boilers you should use the special design U 3 K spezial.

The mounted swing-type check valve prevents the waste water in the pressure pipe from flowing back into the tank. The standard air trap stops annoyance caused by bad smell.

By means of additional adjusting of the cover frame, the Baufix 100 tank can easily and continuously be adapted to the soil and tile conditions.

The unit complies to the EN 12050.

We reserve the right to change specifications without notice. Pump performance is subject to ISO 9906 tolerances.

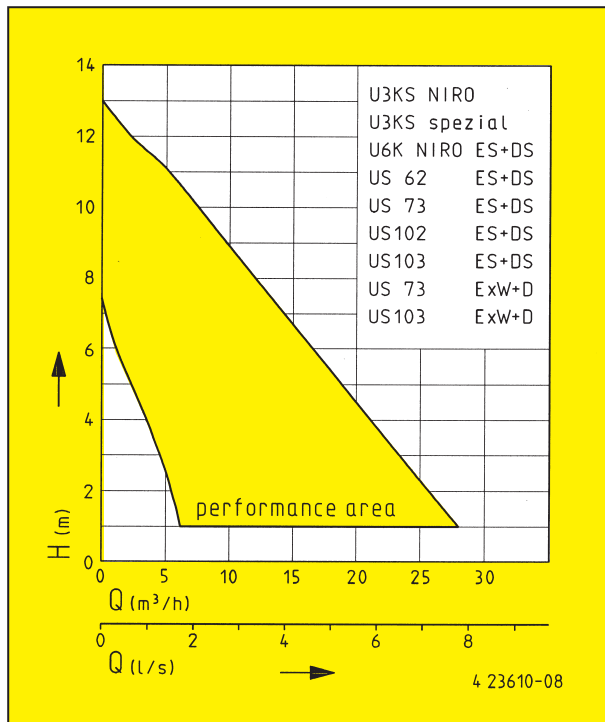

- ▶ Air trap
- ▶ Floor drain
- ▶ Complete pressure pipe in the tank
- ▶ Mounted swing-type check valve
- ▶ Level-compensating frame
- ▶ Provision for extensible chamber neck



## Underfloor sump

Type	max. h x w x l	Weight	Code No.
Baufix 100-tank with floor drain and cover, without pump	600 x 530 x 530 mm	11,5 kg	9706

## Performances

Type	Delivery head H [m]	1	2	3	4	5	6	7	8	9	10	11	12
U 3 KS NIRO	Flow rate Q [m <sup>3</sup> /h]	6,5	5,5	5	4	3	1,5						
U 3 KS spezial		6,5	5,5	5	4	3	1,5						
U 6 K NIRO ES		16	14,5	13	11	9,5	7	4,5	2				
U 6 K NIRO DS		17	16	15	13,5	11,5	10	7,5	4	0,5			
US 62 ES		19	17	15	12	10	8	6	4	2			
US 62 DS		22	20	17	15	12	10	8	6	4			
US 73 ES		19	17	15	12	10	8	6	4	2			
US 73 DS		22	20	17	15	12	10	8	6	4			
US 102 ES/DS		28	26	23	21	19	17	15	12	10	8	5	2
US 103 ES/DS		28	26	23	21	19	17	15	12	10	8	5	2
US 73 Ex W		19	17	15	12	10	8	6	4	2			
US 73 Ex D		22	20	17	15	12	10	8	6	4			
US 103 Ex W/D		28	26	23	21	19	17	15	12	10	8	5	2

## Electrical data





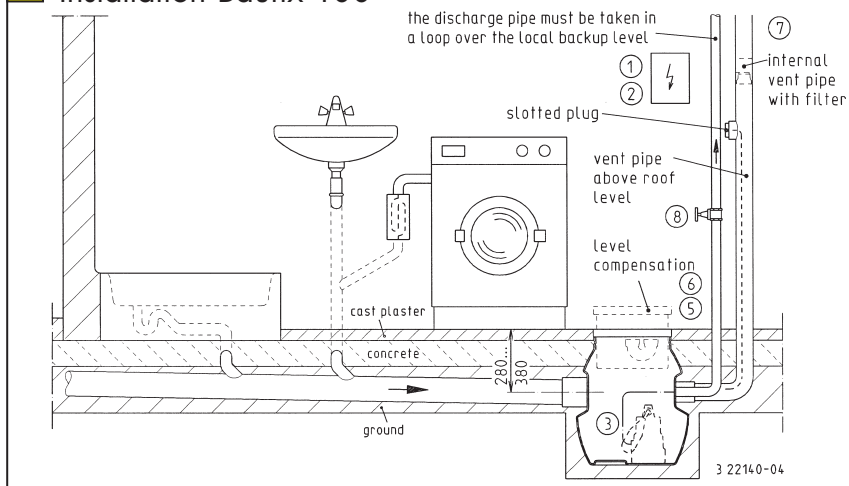

Baufix 100-tank alternative with type	Type of current	Voltage Volt	Motor rating kW		RPM min <sup>-1</sup>	F.L.C. Amp.	Motorprotection	Plug
			P <sub>1</sub>	P <sub>2</sub>				
U 3 KS NIRO	1-phase	1N~230	0,32	0,20	2720	1,4		safety-
U 3 KS spezial	1-phase	1N~230	0,32	0,20	2720	1,4		safety-
U 6 K NIRO ES	1-phase	1N~230	0,70	0,45	2600	3,4		safety-
U 6 K NIRO DS	3-phase	3~400	0,75	0,58	2750	1,3		CEE-
US 62 ES	1-phase	1N~230	0,83	0,50	2500	3,9	incorporated	safety-
US 62 DS	3-phase	3~400	0,85	0,60	2800	1,4	in	CEE-
US 73 ES	1-phase	1N~230	0,83	0,50	2500	3,9	motor	safety-
US 73 DS	3-phase	3~400	0,85	0,60	2800	1,4		CEE-
US 102 ES	1-phase	1N~230	1,37	0,98	2700	6,0		safety-
US 102 DS	3-phase	3~400	1,36	1,06	2740	2,4		CEE-
US 103 ES	1-phase	1N~230	1,37	0,98	2700	6,0		safety-
US 103 DS	3-phase	3~400	1,36	1,06	2740	2,4		CEE-
US 73 Ex W	1-phase	1N~230	0,83	0,50	2510	3,9	in control unit	without
US 73 Ex D	3-phase	3~400	0,85	0,60	2800	1,4	+ winding	without
US 103 Ex W	1-phase	1N~230	1,37	0,98	2700	6,0	thermostat	without
US 103 Ex D	3-phase	3~400	1,36	1,06	2740	2,4		without

## Installation Baufix 100



In case of installation beneath the backpressure level the pressure tube must be taken in a loop over the local backup level acc. to EN 12056. Besides, it must be secured with a EN 12050-4-proofed swing-type check valve. Additionally we recommend an alarm system.

## Accessories

		Code No.						
	<b>1 Alarm system</b> with submersible ball contact switch with 3 m cable, separate, mainsdependent, with potential free contact	16723						
	<b>Alarm system</b> ditto. with 9,5 m cable	24434						
	<b>Alarm system for washing-machines AW 3</b> with submersible ball contact switch with 3 m cable, separate, mainsdependent	25090						
	<b>Alarm system for washing-machines AW 10</b> ditto, with 9,5 m cable	25091						
	<b>Control unit AD 4 Ex W</b> (only for US 73 Ex W) <b>Control unit AD 8 Ex W</b> (only for US 103 Ex W) <b>Control unit AD 23 Ex</b> (only for US 73 Ex D) <b>Control unit AD 25 Ex</b> (only for US 103 Ex D) <b>Air diaphragm control unit</b> (only for Ex-pumps)	25901 25902 9754 9683 1080						
	<b>2 Rechargeable battery</b> for off the line operation of the alarm system	7562						
	<b>3 Seal leak control</b> DKG (only for US-pumps)	252						
	DKG Ex (only for US 73 Ex + US 103 Ex)	249						
	<b>4 Assembly set</b> for LM circuit (installation of a US 73 Ex + US 103 Ex)	22410						
	<b>5 Cover plate</b> to be tiled with floor drain in Niro and syphon	24024						
	<b>6 Cover frame</b> , Niro	28118						
	<b>7 Ventilation</b> , special filter c/w casing	27484						
	<b>8 Stop valve</b> , 1 1/4" (DN 32) PN 16	11836						
	<table border="1"> <thead> <tr> <th>H</th> <th>L</th> <th>D</th> </tr> </thead> <tbody> <tr> <td>110</td> <td>max.60</td> <td>1 1/4"</td> </tr> </tbody> </table>	H	L	D	110	max.60	1 1/4"	
H	L	D						
110	max.60	1 1/4"						

## Mounting arrangement

### Floor level compensation

The cover with round throat shoulder in the shaft opening can be aligned vertically and rotationally. Sealing between tank and cover is achieved by a round sealing cord. This makes it possible to adjust the Baufix to the effective top edge of floor coverings laid later e.g. tiles.

### Extended floor level compensation (adjusted by the customer)

If required, the installation depth can be additionally increased up to approx. 380 mm by the customer, using a commercial 300 mm dia. PVC pipe. The PVC pipe is inserted into the tank instead of the cover frame. The frame is then pushed into the socket of the PVC pipe.

### Air trap

An air trap is provided as standard for the floor drain. The necessary syphon components form part of the scope of supply.

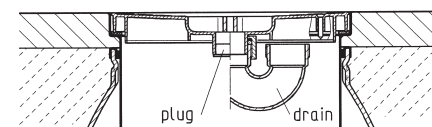
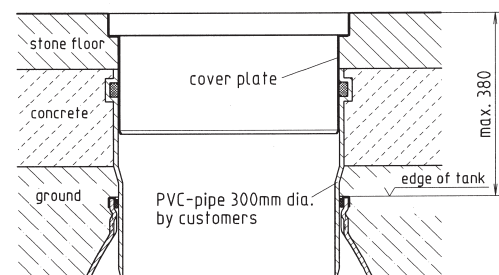
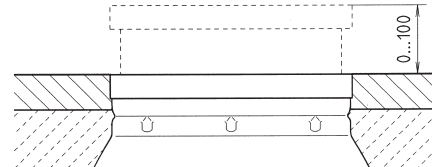

4 22314-03

## Technical data

### Tank

Water-tight PE-tank (70 l) with two connecting branches for inlet DN 100, sump ventilation (DN 70) and a pressure pipe (PVC-pipe  $\varnothing$  40 mm), level-compensating plastic frame, tight plastic cover (screw fitted) and tight floor drain.

### Installation

Place the tank into the prepared pit and adjust the frame to the desired position. Afterwards encase the sump with concrete flush with top edge. Insulation, floor pavement and flooring material will be leveled out by the height-adjustable cover. Screw in the supplied pipe connection into the pressure pipe connection of the pump (shorten pipe length according to specifications). Join the pump to the elastic pipe connection in the tank. Thread the pump's power cable through the ventilation line up to the T-piece (provided by the customer in accordance to the installation drawing). The outlet has to be closed with the supplied stopper. Therefore do not cut off the plug! If a ventilation via roof is impossible the special ventilation (accessory/installation drawing) can be used.

### Scope of supply

Plastic tank for application of a EN 12050 inspected pump with level-compensating plastic cover and cover frame, mounted connecting branches, air trap for floor drain, flexible tube connection, parts for pump assembly and mounted swing-type check valve, (without pump).

